

BIGE

VERSION 1.1

BALOGH

7699 Kensington Court
Brighton, MI 48116-8561
(248) 486-RFID

ABSTRACT:

This document describes the Genius7™ bus communications protocol implementation used to interface one or more **BALOGH BIGE uGenius Gateway Module7™** to a GE Genius 7™ Local Area Network. The **BALOGH uGenius Gateway Module7™ (BIGE)** is equipped with a custom dual **BALOGH** transceiver interface board, a Horner Electric uGenius Gateway Module7™ and a Genius7™ Network Interface board (**GENI7™**). This unit gives the programmer the ability to read data from **BALOGH TAGS**, write data to the **TAGS**, or obtain **BALOGH TAG** status from a remote Genius7™ node. In order to gain access to these basic **BALOGH TAG** functions, the remote system must send Genius7™ "Datagrams" to the **BIGE** as outlined in the remainder of this document.

NOTE:

Notes are used to call attention to information that is significant to the understanding and operation of equipment. This **BALOGH BIGE** manual is based on information available at the time of its publication. We have attempted to provide accurate and up-to-date information. This document does not purport to cover all details or variations in hardware or software; nor does it provide for every possible combination of products. Some features described herein may not be available on all like products. **BALOGH** assumes no obligation to notify holders of this document of any subsequent changes. **BALOGH** makes no representation or warranty, expressed, implied or statutory with respect to, and assumes no responsibility for the accuracy, completeness, or usefulness of the information contained in this manual. No warranties of merchantability or fitness for purpose shall apply.

Gateway Module7™	is a registered trademark of Horner Electric
Genius7™	is a registered trademark of the General Electric Company
GENI7™	is a registered trademark of the General Electric Company
uGeni7™	is a registered trademark of the General Electric Company

Revision: August 27, 2002 © Copyright **BALOGH** 2000

BALOGH 7699 Kensington Court - Brighton, MI 48116-8561 - (248) 486-RFID - Subject to Modifications

Table of Contents

Introduction	Page: 1
Configuration	2
Specifications	3
Hardware Connections	4
Power Requirements	4
Transceiver Connections	5
Network Connection	7
Geni Configuration	8
Geni Bus Software Configuration	9
Communications	12
Request Datagram Format	13
Reply Datagram Format	14
Datagram Request Instructions	17
• Global Data Execution Status.....	19
• Tags Presents Feature.....	20
• Read Status.....	21
• Read Device.....	22
• Write Device.....	24
• Cancel Current Command.....	26
Datagram Replies	27
• Read Status Reply.....	29
• Result Codes.....	30
• BALOGH Status Code Definition.....	32
• Read Device Reply.....	34
• Contents of the Status Block.....	40
Appendix	41
Data Sheets	43

BALOGH BIGE

View of Side Connector Panel GENIUS BUS DIP SWITCHES

1	2	3	4	5	Device	1	2	3	4	5	Device	6	7	BaudRate	8	Outputs
0	0	0	0	0	00	0	0	0	0	0	00001	16	00	153.6 K (EXT)	0	Illegal
1	0	0	0	0	01	1	0	0	0	01000	17	10	38.4 K	1	Normal	
0	1	0	0	0	02	0	1	0	0	01001	18	01	76.8 K			
1	1	0	0	0	03	1	1	0	0	11001	19	11	153.6 K (STD)			
0	0	1	0	0	04	0	0	1	0	00101	20					
1	0	1	0	0	05	1	0	1	0	10101	21					
0	1	1	0	0	06	0	1	1	0	01101	22					
1	1	1	0	0	07	1	1	1	0	11101	23					
0	0	0	1	0	08	0	0	0	1	00011	24					
1	0	0	1	0	09	1	0	0	1	10011	25					
0	1	0	1	0	10	0	1	0	1	01011	26					
1	1	0	1	0	11	1	1	0	1	11011	27					
0	0	1	1	0	12	0	0	1	1	00111	28					
1	0	1	1	0	13	1	0	1	1	10111	29					
0	1	1	1	0	14	0	1	1	1	01111	30					
1	1	1	1	0	15	1	1	1	1	11111	31					

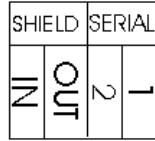
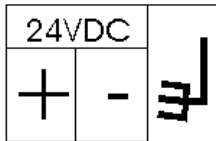
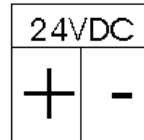
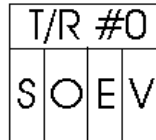

87654321
GENIUS Config.

Down = 1

Introduction

The BIGE (BALOGH Interface to General Electric) series of BALOGH interface modules provide for a simple and efficient two-wire connection between the complete line of BALOGH Radio Frequency Identification Tagging systems and the reliable, high-speed data transfer of the Genius™ LAN network.

The BIGE uses a custom dual channel interface that allows for two BALOGH Transceiver connections at each "serial bus address" on the Genius™ bus. All required hardware to achieve this connection is incorporated within the BIGE unit, thereby reducing the system hardware to one BIGE, two BALOGH Transceivers of the appropriate style, one 24 Volt DC power supply for each point on the network, and appropriate cabling.

Through the use of a simple command set, the BIGE can execute block Reads and block Writes up to 128 bytes in length, request the status of each channel, and using Global data, provide the host with the current execution status of the BIGE. All commands that drive the BIGE reside in the PLC ladder logic program. This helps to eliminate multiple layers of interface programs and devices.

The BIGE unit will interface to the Genius™ bus and communicate with the GE Fanuc Series 90™-70 PLC through the Genius™ Bus Controller module or to a PC based system using the a computer-host bus controller such as the PCIM (Personal Computer Interface Module).

The BIGE is designed to operate with several of the most popular styles of BALOGH R.F.I.D. TAGS. These include the OMA series of Read/Write TAGS available in memories sizes of 64 bytes, 2K bytes, and 8K bytes. The new Read/Write high-speed series of BALOGH OMX TAGS provide 8K bytes of memory and read speeds of 400 microseconds per byte. The low cost read only series of BALOGH TAGS called the OF series.

BIGE Configurations

The table below provides a reference to the BIGE configurations currently available and the BALOGH TAG and Transceiver styles, which apply.

BIGE Part Number	TAG Style	Transceiver Style
BIGE-AA	OMA series Read/Write passive	ERO and ERA series
BIGE-XX	OMX series Read/Write high speed and passive	ERC series
BIGE-FF	OF series read only fixed code passive	ERO and ERA series

Packaging Options:

The BIGE is available in a non-NEMA rated 16 gage steel enclosure designed for permanent backplate mounting inside of a protective enclosure. To install the BIGE:

- A. Drill four starter holes into the mounting surface (backplate) as located in the drawing Appendix.
- B. Secure the BIGE to the backplate with four #6-32 screws.

*Note:

There is an optional NEMA-12 rated enclosure with quick connectors available.

BIGE Specifications

Characteristic	Symbol	Unit	Value
Mass	m	Kg	1.15
Temperature Ambient MIN	Tm	C	0
Temperature Ambient MAX	TM	C	+60
Degree of Protection	IP	.	00
Voltage	V dc	V	24
Tolerance	V dc	V	+10%,-10%
Ripple	V ac	V	<2%
Current Operational (without trans.)	Is	mA	500
Current Peak (without trans.)	Ip	A	2
Dimensions		inches	6.1"L x 4.6"W x 2.34"D
Serial Communications			Genius™ Network Interface (GENI™)
Operational Environment			0 to 95% relative humidity (non-condensing)
Inverse polarity protection			YES
Maximum transceiver cable length		meter	50

BIGE Hardware Connections

Below is a side view depicting the BIGE hardware connections and configuration switches. All connections are made to the removable Phoenix screw connectors. See Appendix for information on the specific connector types used.

View of Side Panel

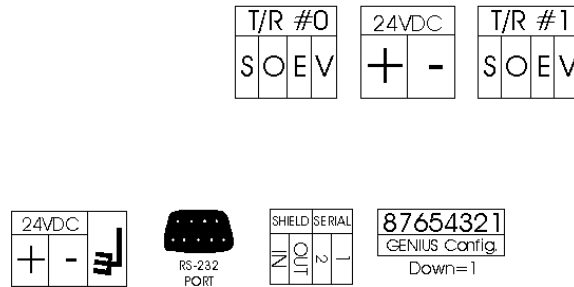

Power Requirements:

The BIGE requires a regulated 24 VDC power supply capable of providing in excess of 2 Amps peak current output. The typical current required during normal operation is 500 mA DC. This DOES NOT include the Transceivers current requirements. It is recommended that peak current output of the power supply be rated according to the number of BIGE connections expected to each power supply.

The BIGE requires two power connections to a common 24VDC power supply. These are located at positions 2 and 4 of the side view drawing. These connections may be jumpered together. The connections are depicted below for clarity.

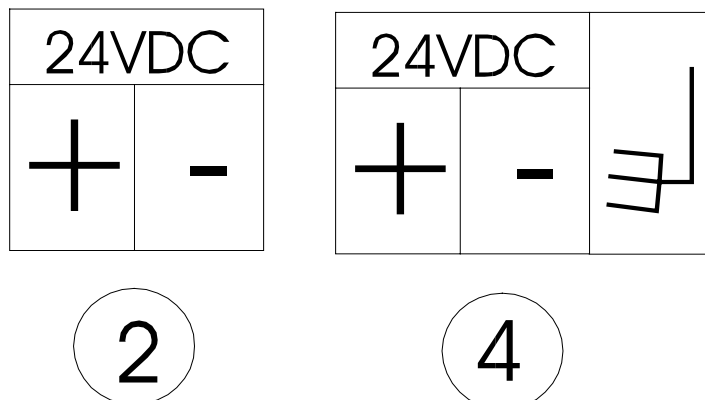

BALOGH Transceiver Connections

The BIGE provides two separate channels from which each BALOGH Transceiver is connected. The Transceiver connection is made using a four conductor shielded cable with overall foil/braid shield and a drain wire. Each Transceiver can be run up to 50 meters (164 feet) from the associated BIGE. The Transceiver wiring should be run with other low voltage signal type communications. These connections are located at positions 1 and 3 of the side view drawing. The connections and their meanings are depicted below for clarity.

1

3

T/R #0			
S	O	E	V

T/R #1			
S	O	E	V

Transceiver Connections and Meanings

Terminal Number	Terminal Function	Transceiver Connection
S	Receives serial communications from the Transceiver	S
O	Signal ground for the Transceiver	O
E	Transmits serial communications to the Transceiver	E
V	Power connection to the Transceiver	V

The wiring schematic for the connection of a BIGE to a BALOGH Transceiver is as follows:

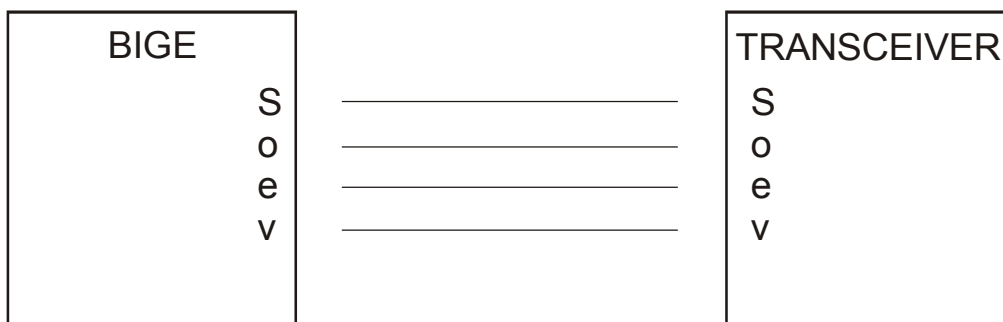

RS-232 Connection:

This port is reserved for future use.

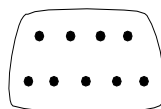

RS-232
PORT



Genius™ Network Connection

The BIGE connects to the Genius™ LAN as a typical GENI™ based device. This connection is located at position 6 of the side view drawing. The connections and their associated meanings are depicted below for clarity. Please refer to the *Genius™ I/O System and Communications User's Manual-Volume 1* GEK-9048 for specific information regarding maximum cable length, wiring guidelines, cable selection, connecting devices to the bus, and proper shielding and termination practices required.

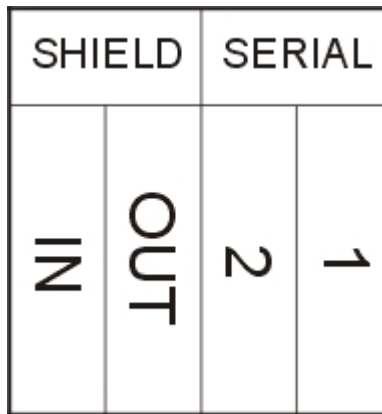

Genius™ Bus Connections and their associated meanings.

Genius™ Terminal	Terminal Meaning
1	Serial 1
2	Serial 2
OUT	Shield Out
IN	Shield In

GENI™ Configuration

The BIGE'S integrated GENI™ board is equipped with a bank of 8 "DIP" switches. These DIP switches are located at position 7 of the side view drawing. These switches are used to configure the Genius™ "Serial Bus Address", or "Device Number" for the BIGE, and set the Genius™ baud rate. Each device on the Genius™ Network must have a unique "Device Number"(0 to 31). The BIGE may be configured to any device number. The available DIP switch settings are illustrated on the BIGE and are reprinted below for clarity.

GENIUS BUS DIP SWITCHES

1	2	3	4	5	Device	1	2	3	4	5	Device	6	7	Baud Rate	8	Outputs
0	0	0	0	0	00	0	0	0	0	1	16	0	0	153.6 K (EXT)	0	Illegal
1	0	0	0	0	01	1	0	0	0	1	17	1	0	38.4 K	1	Normal
0	1	0	0	0	02	0	1	0	0	1	18	0	1	76.8 K		
1	1	0	0	0	03	1	1	0	0	1	19	1	1	153.6 K (STD)		
0	0	1	0	0	04	0	0	1	0	1	20					
1	0	1	0	0	05	1	0	1	0	1	21					
0	1	1	0	0	06	0	1	1	0	1	22					
1	1	1	0	0	07	1	1	1	0	1	23					
0	0	0	1	0	08	0	0	0	1	1	24					
1	0	0	1	0	09	1	0	0	1	1	25					
0	1	0	1	0	10	0	1	0	1	1	26					
1	1	0	1	0	11	1	1	0	1	1	27					
0	0	1	1	0	12	0	0	1	1	1	28					
1	0	1	1	0	13	1	0	1	1	1	29					
0	1	1	1	0	14	0	1	1	1	1	30					
1	1	1	1	0	15	1	1	1	1	1	31					

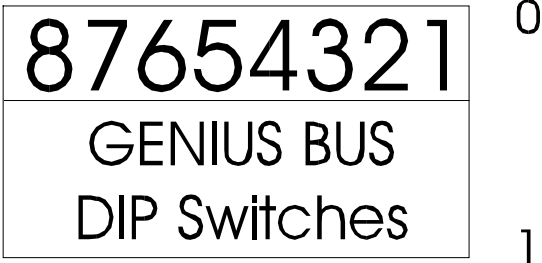

Example of switch settings:

SW1	SW2	SW3	SW4	SW5	SW6	SW7	SW8
0	1	0	0	0	1	1	1

This DIP switch configuration would result in a "Serial Bus Address" of 2, and a baud rate of 153.6K standard. Switch number 8 must always be in the 1's position.

Note:

When looking at the side view of the BIGE, a switch is in the 1's position when it is set in the direction of the BIGE mounting backplate.

BIGE/Genius™ Bus Configuration

When connecting the BIGE as a device on the Genius™ LAN it is necessary to configure the Series 90™-70 PLC Genius™ Bus Controller in order to recognize the BIGE as a device on the LAN. For detailed information on the setting up a Bus Controller please refer to the **Series 90-70 Genius™ Bus Controller User's Manual GFK-0398**.

When configuring the Genius™ Bus Controller it is important to verify that all BIGE devices have the same baud rate as the Genius™ Bus Controller. Selection of the baud rate depends upon the application, see the **Genius™ I/O System and Communications User's Manual-Volume 1 GEK-90486** for details regarding baud rate selection.

Configuring BIGE'S on the Bus:

After configuring the Bus Controller each BIGE must be assigned a "Device Number" or Genius™ Bus address. This is done in the bus configuration screen provided for the Genius™ Bus Controller in the Logicmaster 90 software. Once a "Device Number" is selected the option of **other (F7)** is used to select "other" modules that may reside on the Bus. The BIGE is identified as a **GENI™-based Genius™ Net I/Face-global data** device. This option should be entered. The BIGE will provide one word of Global Data to the PLC. This data details the current operation of each Transceiver channel and is explained later in the manual. This information must be provided in the set up screen by choosing a **Config. Mode** setting of **Manual**. The next setting called **To** will inform the PLC of what address to store the Global data at and the type of memory (**%I, %Q, %G, %AI, %AQ, or %R**) the Global data should be stored as. The last piece of information **Input Len** is set to one (1). This indicates that one (1) word or 16 bits of data will be returned as global data. Other settings should be left in their default modes. This process needs to be repeated for each BIGE that will reside on the Bus.

The following screens describe a typical setup for the BIGE when configuring it to the Genius™ Bus Controller.

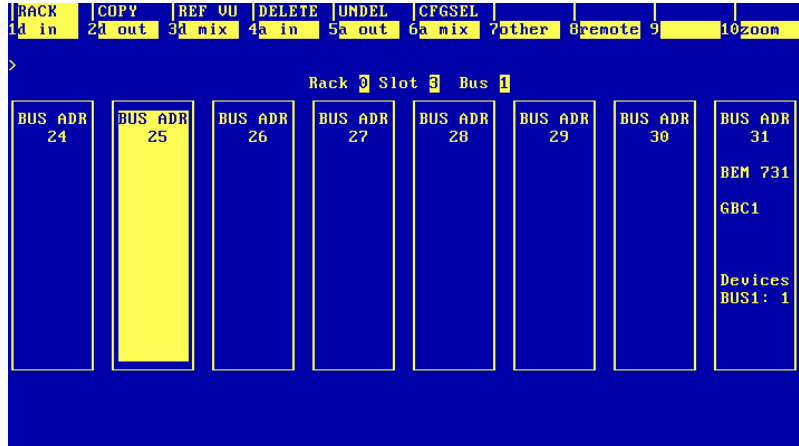

Choose an available "Genius™ Bus Address".
Select the option of **other (F7)** to see a catalog of available devices.

BIGE/Genius™ Bus Configuration (continued)

```

RACK 1d in 2d out 3d mix 4a in 5a out 6a mix 7other 8 9 10
>
Rack 0 Slot 3 Bus 1
SOFTWARE CONFIGURATION
BUS ADR 25 Catalog #:
  CATALOG # DESCRIPTION TYPE
  7 IC660CBB902 SERIES 6 GENIUS BC W/DIAG S 6 GBC
  8 IC660CBB903 SERIES 6 GENIUS BC WO/DIAG S 6 GBC
  9 IC660ELB906 PERSONAL COMPUTER I/F (PCIM) PCIM
  10 IC693CMM301 GENIUS COMMUNICATIONS MODULE GENCOM
  11 IC693CMM302 ENHANCED GENIUS COMM MODULE GENCOM
  12 IC697BEM731 90-70 GENIUS BUS CONTROLLER GBC1
  13 GENI-BASED GENIUS NET I/FACE-global data GENIBAS
  14 GENERIC I/O GENERIC GENIUS I/O DEVICE GEN_I/O
  << CURSOR TO THE DESIRED CATALOG NUMBER AND PRESS THE ENTER KEY >>
  << PRESS PGDN KEY FOR NEXT PAGE, PGUP KEY FOR PREVIOUS PAGE >>
  
```

Cursor to the GENI™-BASED listing and press enter.

```

RACK 1d in 2d out 3d mix 4a in 5a out 6a mix 7other 8 9 10
>
Rack 0 Slot 3 Bus 1
SOFTWARE CONFIGURATION
BUS ADR 25 Catalog #: GENI-BASED GENIUS NET I/FACE-global data
ELB 905
GENIBAS ---- RECEIVE GLOBAL DATA ---- Redundancy?: NO
Config Mode: MANUAL Input Def : OFF
  
```

Cursor to the Config Mode Option. Use the TAB key to select MANUAL.

BIGE/Genius™ Bus Configuration (continued)

```

RACK
1d in 2d out 3d mix 4a in 5a out 6a mix 7other 8 9 10
>
                                     Rack 0 Slot 3 Bus 1
                               SOFTWARE CONFIGURATION
-----
BUS ADR  Catalog #: GENI-BASED          GENIUS NET I/FACE-global data
  25
ELB 905
GENIBAS  ---- RECEIVE GLOBAL DATA ----      Redundancy?: NO
Config Mode: MANUAL                          Input Def : OFF
To       : 2R00001
Input Len : 1

```

Enter the type of memory and the address location that the Global data will occupy.
The length should be 1 word or 16 bits if using Bit-oriented memory.

BIGE Communications

This section is intended to provide a general overview on how the BIGE receives communications from a host G.E. Fanuc Series 90tm-70 via the Geniustm Bus Controller. For a more detailed discussion on these topics please refer to the **Series 90tm-70 PLC Geniustm Bus Controller User's Manual GFK-0398** and the **Geniustm I/O System and Communications User's Manual-Volume 1 GEK-90486**.

The BIGE is designed to act as a slave to the host controller system. Therefore, all programming that is used to drive a BIGE will reside in either the form of ladder logic or another programming method available to the PLC.

The BIGE will furnish the host controller with information in two forms. The BIGE supplies command execution status information to the host as **Global data**, which occurs automatically. Other command information (Reads, Writes, Status, & Cancel) is executed in response to requests issued by the host controller.

Specifically, the Series 90tm-70 PLC uses a communication package called the **Datagram** to transmit data via the Geniustm Bus Controller. A Datagram is a message from one device on the bus to another device on the bus.

The Series 90tm-70 PLC sends Datagrams via the **COMREQ** instruction. The COMREQ instruction will automatically configure and send the Datagram once it has been properly formatted with the application specific data. This data is placed together in adjacent locations in the CPU memory using Block Moves or similar program instructions. The following discussion will describe the format of the data that comprises the **Data Block** field of a datagram. The Data Block field will contain information that is specific to the operation of a BIGE.

BIGE Request Datagrams:

A request Datagram Data Block is comprised of the following areas of information.

- 1.) Command Content:
Information that directs the BIGE to either Read, Write, request Status, or Cancel a command.
- 2.) Datagram Content:
Information that provides specific details about the instruction to be preformed.

BIGE Request Datagram Format

The BIGE will respond only to Datagrams with a function code of 40H. The BIGE will only respond to Datagrams with the following sub-function codes. The table below describes the sub-function codes and their meanings.

Command Request	Sub-Function Code	Meaning
Read Status	08 Hex	Read channel status
Read Device	1E Hex	Read TAG data
Write Device	20 Hex	Write TAG data
Cancel Current Command	30 Hex	Abort Reading or Writing "with wait" command

The table below generally describes the type of information that comprises a BIGE Request Datagram.

	Parameter	Size
Command Content	Device Number (Genius Address)	1 Word
	Function Code	1 Word
	Sub-Function Code	1 Word
	Priority	1 Word
	Length (bytes of datagram content)	1 Word
Datagram Content	Reserved (always 0)	Low byte
	Transceiver Channel #	High byte
	Wait or No Wait (for TAG)	Low byte
	Low Byte of TAG Address	High byte
	High Byte of TAG Address	Low byte
	Number of bytes to Read/Write	High byte
	Data (if writing to TAG)	Low byte

BIGE Reply Datagram Format

A Reply Datagram is comprised of the following areas of information:

1.) Command Content:

This information contains the Device Number of the BIGE that responded, the number of words contained in the response, the function code, and the sub-function code + 1.

2.) Datagram Content:

This information will contain the results of the command that was executed or error information.

The BIGE is capable of returning datagrams with the following sub-function codes. The sub-function code in the Reply Datagram is the sub-function code of the request datagram plus one.

Command Reply	Sub-Function Code	Meaning
Read Status Reply	09 Hex	Returns Status or Error Codes
Read device Reply	1F Hex	Returns TAG data

BIGE Reply Datagram Format (continued)

The table below describes in general the type of information that comprises a BIGE datagram Reply.

	Parameter	Size
Command Content	Device Number (Genius™ Address)	Low byte
	Number of bytes returned (count begins after the sub-function code).	High byte
	Function Code	Low byte
	Sub-function Code + 1	High byte
Datagram Content	Result Code	Low byte
	Transceiver Channel #	High byte
	Wait Status	Low byte
	Low Byte (TAG Address)	High byte
	High Byte (TAG Address)	Low byte
	Number of bytes returned	High byte
	Data read or status information	Low byte

Datagram Requests and their corresponding Replies:

The "Read Status Reply" datagram is returned in response to a "Read Status" request, and also in response to any Read request or Write request that is terminated due to an error.

The "Read Device Reply" is returned in response to a successful "Read Device" request.

The BIGE will not generate a reply message to a successful "Write Device" and "Cancel Current Command" request.

DATAGRAM REQUEST INSTRUCTION

BALOGH

7699 Kensington Court
Brighton, MI 48116-8561
(248) 486-RFID

Global data BIGE execution status

Two bytes of data (one word) are emitted by the BIGE as Global data, any Genius™ device on the LAN may obtain the current BIGE status via global data emitted by the BIGE. This information is stored in the memory location assigned during the BIGE'S configuration on the Genius™ Bus Controller. Each byte of this word represents the current status of a Transceiver channel on the BIGE. The low byte representing channel 0, and the high byte representing channel 1.

These bytes will indicate:

Confirmation of a command received.

Type of command that is currently awaiting completion or was last completed.

Current execution status of a command at the channel.

Error status of command in progress.

Presence of a TAG in the Transceivers field.

The table below lists these possible states and their bit positions.

TABLE A.

Bit 7	Bit 6	Bit 5	Bit 4	Bit 3	Bit 2	Bit 1	Bit 0
TAG Present	Error	STAT1	STAT0	Low Batt.	CMD1	CMD0	RXCMD

RXCMD - Toggles each time a request is received.

CMD (1-0) - Represents the current or last completed command
 00 - No Commands Received Yet
 01 - Status Command
 10 - Read Command
 11 - Write Command

Low Battery - Low Battery Bit for TAG Memory Back-Up (SRAM TAGS Only).

STAT (1-0) - Represents the current state of the channel
 00 - No Commands Received Yet
 01 - Command in Progress
 10 - Command Complete
 11 - Command Aborted

Error - Set to 1 when an error occurs during a commands execution. Set to 0 on next request.

TAG Present - Set to 1 when a TAG is seen by the Transceiver. Set to 0 when a tag is not seen by the Transceiver.

Tag Presence Feature

The TAG presence feature is enabled on power-up and can be modified by sending a non-zero "Global TAG Status Update Frequency" byte. This value represents the number of 10 ms time periods between TAG status updates. If the value received is 0, the status update feature is disabled. The BIGE will convert any non-zero value that is less than 10 to a time base of 100 ms. The updated frequency is set to a default of 100 ms upon power-up.

The following formula can be used to calculate the TAG presence update frequency:

$GTSUF * 10 \text{ ms} = \text{Frequency of status updates.}$

GTSUF is defined as the Global TAG Status Update Frequency byte that is sent in the read status request datagram.

Value of 0 - Disables status update feature.

Values (1-10) - Defaults to 100 ms updates.

Values (11-255) - Above formula applies.

Example:

If TAG status update frequency of 1.00 second were desired the formula would be:

GTSUF value = 100
 $100 * 10 \text{ ms} = 1000 \text{ ms or } 1 \text{ second.}$

This would result in a delay of 1 second between the time a TAG arrived or departed and the time the Global TAG Presence bit responded.

Read Status

The Read Status command is used to obtain information regarding the current state of one of the channels on the BIGE. The status of the Transceiver, TAG presence, and TAG errors can be determined using this command. This command can also be used to determine the status of the TAG'S battery. Please see the BALOGH status word definition for more details.

The BIGE will reply to the Read Status request by reading the status of the specified channel and returning a Read Status Reply datagram message. See Datagram Replies for more details.

The COMREQ #14: Send Datagram Command can be used to send the Read Status Datagram.

The COMREQ #13: Deque Datagram Command can then be used to receive the reply.

The COMREQ #15: Request Datagram Reply Command can be used to send and receive the reply in one step.

Table 1.
Read Status Command Content:

Description	Data
Device Number (Genius™ address)	00H to 1FH
Function Code (BALOGH Device)	40H
Sub-function Code (Read Status Command)	08H
Priority (0 = low priority)	00h or 01h
Length (2 or 3 bytes)	02H

The Device Number represents the Genius™ bus address assigned to the BIGE. The Function Code identifies the message as being directed to a BALOGH BIGE unit. This value is always 40 Hex or 64 Decimal. The Sub-function Code is 08H, which executes the Read Status command. The Priority value determines the priority level at which the datagram is sent. The Length parameter refers to the length of the data in bytes contained in the Datagram content, which is detailed below.

The Datagram Content may consist of 1 word or 2 bytes if the Global TAG Status Update Frequency needs no modifications. If this feature is to be modified, then 3 bytes will be required.

Table 2.
Read Status Datagram Content:

Description	Data
Reply priority (0 = normal, 80h = high)	0 or 80h Low byte
Transceiver Channel #	0 or 1 High byte
Global TAG Status Update Frequency	0 to FFh Low byte

Read Device

The Read Device command is used to read data from a TAG at one of the Transceiver channels of the BIGE. The BIGE will act upon the Read Device request by attempting to read the specified TAG data at the given starting address. If a read TAG "With Wait" is specified, the BIGE will wait indefinitely for the channel to return the specified data. The Read TAG "With Wait" mode can be terminated prior to the read occurring if an error occurs while the command is in process, or if the host sends a Cancel Current Command Datagram. By issuing the command with "No Wait" the BIGE will attempt to read the TAG immediately. If the TAG is not currently present, a Read Status Reply Datagram will be returned with the appropriate error code.

The BIGE will respond with a Read Device Reply Datagram message when the read has been successfully completed, or with a Read Status Reply datagram message if an error has occurred during processing. In the case of an error, the Result code that is returned in the reply will be a value other than zero. It is a good practice to verify the value returned in the Result code in order to distinguish between a good response or a possible error. If the host decides to cancel the command using the cancel current command datagram, then no response is given. See the Read Status Reply and Read Status Reply message sections for a more detailed description of the possible reply messages.

The COMREQ #14: Send Datagram Command can be used to send the Read Status Datagram.
The COMREQ #13: Dequeue Datagram Command can then be used to receive the reply.
The COMREQ #15: Request Datagram Reply Command can be used to send and receive the reply in one step.

Table 6.
Read Device Command Content:

Description	Data
Device Number (Genius address)	00H to 1FH
Function Code (BALOGH Device)	40H
Sub-function Code (Read Device Command)	1EH
Priority (0 = low priority)	00h or 01h
Length (Always 6 bytes)	06H

The Device Number represents the Genius™ bus address assigned to the BIGE. The Function Code identifies the message as being directed to a BALOGH BIGE unit. This value is always 40 Hex or 64 Decimal. The Sub-function Code is 1EH, which executes the Read Device command. The Priority value determines the priority level at which the datagram is sent. The Length parameter refers to the length of the data in bytes contained in the datagram content, which is detailed on the following page.

Read Device (continued)

Table 7.
Read Device Datagram Content:

Description	Data
Reply priority (0 = normal, 80h = high)	0 or 80h Low byte Word 1
Transceiver Channel #	0 or 1 High byte Word 1
Wait for TAG (1 = wait)	0 or 1 Low byte Word 2
Low Byte of TAG Address	0 to FFH High byte Word 2
High Byte of TAG Address	0 to 1FH Low byte Word 3
Number of Bytes to Read (128 bytes max)	0 to 80H High byte Word 3

Note:

All of BIGE'S instructions use Function Code of 40H. For more detail on sending and receiving Datagrams with COMREQ commands for the GE PLC 90-70, refer to the Genius™ Bus Controller User's Manual GFK-0398C. Examples can be found in the Appendix of this manual.

Write Device

The Write Device command is used to Write data to a TAG at one of the BIGE Transceiver channels. The BIGE will not send a reply datagram to the Write Device command unless an error has occurred during processing. In this a case, a Read Status Reply message is returned. A COMREQ #14: Send Datagram command can be used to send a Write Device command. See the Read Status Reply message for more details regarding the error message reply.

The BIGE will act upon the Write Device request by attempting to write the specified TAG data at the given starting address. If a write TAG "With Wait" is specified, the BIGE will wait indefinitely for the TAG to appear. The Write TAG "With Wait" mode can be terminated prior to the write occurring if an error occurs while the command is in process, or if the host sends a Cancel Current Command datagram. By issuing the command with "No Wait", the BIGE will attempt to write the TAG immediately. If the TAG is not currently present, a Read Status Reply Datagram will be returned with the appropriate error code.

The BIGE will respond with a Read Status Reply Datagram message if an error has occurred during processing. In the case of an error, the Result code that is returned in the reply will be a value other than zero. If the host decides to cancel the command using the cancel current command datagram, then no response is given. See the Read Status Reply message sections for a more detailed description of the possible reply messages.

Table 9.
Write Device Command Content:

Description	Data
Device Number (Genius™ address)	00H to 1FH
Function Code (BALOGH Device)	40H
Sub-function Code (Write Device Command)	20H
Priority (0 = low priority)	00h or 01h
Length (# data bytes + 6)	07H to 86H

Write Device (continued)

The Device Number represents the Genius™ bus address assigned to the BIGE. The Function Code identifies the message as being directed to a BALOGH BIGE unit. This value is always 40 Hex or 64 Decimal. The Sub-function Code is 20H, which executes the Write Device command. The Priority value determines the priority level at which the datagram is sent. The Length parameter refers to the length of the data in bytes contained in the datagram content, which is detailed below.

Table 10.
Write Device Datagram Content:

Description	Data	
Reply priority (0 = normal, 80h = high)	0 or 80h	Low byte Word 1
Transceiver Channel #	0 or 1	High byte Word 1
Wait for TAG (1 = wait)	0 or 1	Low byte Word 2
Low Byte of TAG Address	0 to FFH	High byte Word 2
High Byte of TAG Address	0 to 1FH	Low byte Word 3
Number of Bytes to Write + 6	07H to 86H	High byte Word 3
Data to Write in the TAG	XX	Word 4....

Cancel Current Command

The Cancel Current command is used to force a specified Transceiver channel to cancel any Read Device or Write Device requested with WAIT. If the specified channel is not currently in "Wait Mode" this command is ignored.

Table 11.
Cancel Current Command Content:

Description	Data
Device Number (Genius™ address)	00H to 1FH
Function Code (BALOGH Device)	40H
Sub-function Code (Cancel Command)	30H
Priority (0 = low priority)	00h or 01h
Length (Always 2 bytes)	02H

A COMREQ #14: Send Datagram Command can be used to send the datagram. The Function Code is 40H and the Sub-function code is 30H. The Datagram Content is 2 bytes or 1 word, which is listed in Table 12.

Table 12.

Description	Data
Reserved (always 0)	0
Transceiver Channel #	0 or 1

The BIGE will not reply to the Cancel Current command Datagram.

Note:

All of BIGE'S instruction set Function Codes are 40H. For more detail on sending and receiving Datagrams with COMREQ commands for the GE PLC 90-70, refer to the Genius™ Bus Controller User's Manual GFK-0398C. Examples can be found in the Appendix of this manual.

Datagram Replies

BALOGH

7699 Kensington Court
Brighton, MI 48116-8561
(248) 486-RFID

Read Status Reply

The Read Status Reply datagram is returned by the BIGE in response to a Read Status request Datagram. This Datagram reply is also returned in response to a Read Device or Write Device Request that results in an error.

Read Status Reply Command Content:

Description	Data
Device Number (Genius™ Address)	00H to 1FH
Number of Bytes Returned (after the sub-function code)	07H (when result code = 00H or 08H) See result codes for details.
Function Code	40H
Sub-function Code	09H

The Read Status Reply will be 7 bytes in length when a Result Code of 00H or 08H is returned. These bytes will be returned as follows.

Read Status Reply Datagram Content:

Description	Data
Result Code	0 to 8 Low byte Word 1
Transceiver Channel #	0 or 1 High byte Word 1
Wait Status of Current Command	0 or 1 Low byte Word 2
Low Byte TAG Address of Current Command	XX High byte Word 2
High Byte TAG Address of Current Command	XX Low byte Word 3
Number of Data Bytes (always 1)	1 High byte Word 3
BALOGH Status Code	YY Low byte Word 4

Result Codes

The value returned in the Result Code field will provide the following information:

Result Code = 00H

A Result code of zero is returned when no errors have been found during the execution of a Read Status Request. The value returned in the BALOGH Status code field is used to determine the presence or absence of the RF TAG. The information given in the status code field is only valid when a Result Code of (00H or 08H) is returned. Here are some typical status codes.

Result code	BALOGH Status code	Meaning
Result code = 00H	00H	TAG not present
Result code = 00H	20H	TAG present
Result code = 00H	21H	TAG still present following last command

- See status code definition for other codes combinations.

Result Code = 08H

A Result Code of eight (08H) is returned when an error is found during the execution of a Read Status Command, Read Device Command or Write Device Command. The value returned in the BALOGH Status code field is used to determine the specific type of error encountered. The information given in the status code field is only valid when a Result Code of (00H or 08H) is returned. Here are some typical status codes.

Result code = 08H	BALOGH Status Code	Meaning
Result code = 08H	12H	Transceiver channel has been reset
Result code = 08H	1BH	Invalid TAG address requested
Result code = 08H	1CH	Transceiver fault
Result code = 08H	1DH	Communication error between TAG and Transceiver
Result code = 08H	1EH	Loss of TAG'S memory
Result code = 08H	1FH	TAG communication was interrupted or TAG is not present

- See status code definition for other codes combination.

Result Codes (continued)

Result Code = 04H

A Result code of 04H is returned if the BIGE is Busy processing the last request while the host issues new request. The Length parameter in the Command Content Block is equal to 1 the values present in the Wait Status field, TAG address field, and BALOGH status code do not apply.

Result Code = 04H

Read Status Reply Command Content:

Description	Data
Device Number (Genius™ Address)	00H to 1FH
Number of Bytes Returned (after the sub-function code)	01H (when result code = 04H)
Function Code	40H
Sub-function Code	09H

Result Code = 04H

Read Status Reply Datagram Content:

Result Code	04H
-------------	-----

The table below is a summary of the result codes and their meanings.

TABLE 4.

Result Code	Description
0	No error
1	No reply from TAG at all
2	No reply from TAG after start
4	Busy processing last command
8	BALOGH error

BALOGH Status Code Definition

Included in the Read Status Reply is a BALOGH status code, which provides additional data regarding the particular channel that is currently being accessed. This status byte is returned in response to a Read Status request datagram and is also returned if an error occurs during the processing of a Read Device or Write Device request. The following is a break down of the status code byte and a description of each of the bit locations that make up this value.

Status Code:

MSB				LSB			
Not Used	TAG Battery Fault	TAG Present	General Fault	F3	F2	F1	F0

TAG Battery Fault - Bit set high indicates that a low or faulty battery has been detected on TAG that is currently in the field.

TAG Present - Bit set high indicates that a TAG is present in the Transmission zone of the Transceiver.

General Fault - Bit set high indicates the occurrence of an operational fault. Bits F3 through F0 define the specific fault type.

Specific Fault Definitions:

F3	F2	F1	F0	Meaning
0	0	1	0	Result of EMI disturbance and present at power-up
1	0	1	1	Invalid TAG address requested
1	1	0	0	Transceiver fault detected
1	1	0	1	Non-synchronized communications detected
1	1	1	0	TAG memory fault
1	1	1	1	TAG to Transceiver communications interrupted

BALOGH Status Code Definition (continued)

This table represents the hexadecimal equivalent of the specific fault types.

Status Byte (Hex)	Meaning
02 H	This fault is present as a result of a reset condition caused upon power-up or due to an electrical disturbance.
0B H	Indicates that an invalid TAG address has been requested by the current Read/Write command.
0C H	Indicates that the Transceiver associated with this channel is improperly wired or is faulty. Check for proper wiring and loose connections.
0D H	Indicates that the communications between the TAG and Transceiver is not synchronized. This error applies only to OMI/OMI-FR type TAGS.
0E H	Indicates a loss of the TAG'S SRAM memory backup. This fault will occur if the TAG'S battery is either low, removed, or damaged.
0F H	Indicates that communications between the TAG and Transceiver was interrupted before the dialogue could be successfully completed. TAG not in zone.

Read Device Reply

The Read Device Reply datagram is sent by the BIGE in response to a successful completion of a Read Device request. The length of the reply is 6 bytes plus the amount of data read from TAG.

Read Device Reply Command Content:

Description	Data
Device Number (Genius™ Address)	00H to 1FH
Number of Bytes Returned (after the sub-function code)	07H to 86H
Function Code	40H
Sub-function Code	1FH

Read Device Reply Datagram Content:

Description	Data
Result Code (always 0)	0 Low byte Word 1
Transceiver Channel #	0 or 1 High byte Word 1
Wait Status of Reply (1 = with wait)	0 or 1 Low byte Word 2
Low Byte of TAG Address where Read Data Reply began	XX High byte Word 2
High Byte of TAG Address where Read Data Reply began	XX Low byte Word 3
Number of Data Bytes Read (128 bytes max)	1 to 80H High byte Word 3
Actual Data Read from TAG	XX Word 4...

Read Device Reply (continued)

Example 1.

This example is a command block of how the Request Datagram Reply Command, COMREQ #15, could be structured to Read Status of the BIGE device number 2, Transceiver channel 0 linked from rack 0 and slot 3 of the GE PLC 90-70.

COMREQ #13 Instruction Block:

Address:	Command Length	11
Address +1:	No Wait	0
Address +2:	Status Block memory type	8
Address +3:	Status Block offset	10
Address +4:	Idle timeout value	0
Address +5:	Max. communication time	0
Address +6:	Command Number	15
Address +7:	Device number of the device to receive the message	2
Address +8:	Function Code	64 decimal (40 hex)
Address +9:	Sub-function Code of datagram to be sent (in hex)	8
Address +10:	Priority	0
Address +11:	Datagram length in bytes	2
Address +12:	Sub-function code for reply (in hex)	9
Address +13:	Memory type for reply	8
Address +14:	Memory Offset	20
Address +15:	Maximum data memory length needed	7
Address +16:	Datagram Content	0

The COMREQ status will be returned in registers 11 and 12 which is an offset by one of the data entered in the COMREQ block.

The COMREQ reply from the BIGE, which is the BIGE Status data, will be returned in registers 21-28 offset by one of the data in the COMREQ block. Refer to the Read Status section of this manual to find the definitions of the reply data.

Read Device Reply (continued)

Example 2.

This example is how a Read Device could be instructed to read 128 bytes beginning at address 0302 Hex of the TAG through Transceiver Channel 1 with Wait using a COMREQ #14 and a COMREQ #13 to retrieve data after a read has occurred. The BIGE is linked from rack 0, slot 3 and is device number 2.

COMREQ #14 Instruction Block:

Address	Command Length	9
Address +1:	No Wait	0
Address +2:	Status Block memory type	8
Address +3:	Status Block offset	10
Address +4:	Idle timeout value	0
Address +5:	Max. communication time	0
Address +6:	Command Number	14
Address +7:	Device number to receive the message	2
Address +8:	Function Code	64 Decimal or 40 Hexadecimal
Address +9:	Sub-function Code (hex)	30 Decimal 1E Hexadecimal
Address +10:	Priority	0
Address +11:	Datagram Length (in bytes)	6
Address +12:	Datagram Content	0100 hex Word1
Address +13:	Datagram Content	0201 hex Word2
Address +14:	Datagram Content	8003 hex Word3

Read Device Reply (continued)

COMREQ #13 Instruction Block:

Address	Command Length	7
Address +1:	No Wait	0
Address +2:	Status Block memory type	8
Address +3:	Status Block offset	10
Address +4:	Idle timeout value	0
Address +5:	Max. communication time	0
Address +6:	Command Number	13
Address +7:	Maximum data memory length (in words)	69
Address +8:	Memory Type	8
Address +9:	Starting Address	20
Address +10:	Function Code of Datagram (FF hex to match any)	64 decimal, 40 or FF hex
Address +11:	Sub-function Code of Datagram (FF hex to match any)	1F or FF hex
Address +12:	Device Number (sender)	2

The COMREQ #13: Deque Command can be triggered from the Global status word operation complete bit after a read with wait has taken place.

Read Device Reply (continued)

Example 3.

This example is how a Write Device instruction could be formatted to write without wait 128 bytes of data to address 1122 Hex of a TAG through Transceiver channel 0, BIGE device number 2, linked from rack 0, slot 3 of a GE PLC 90-70.

Address	Command Length	73
Address +1:	No Wait	0
Address +2:	Status Block memory type	8
Address +3:	Status Block offset	10
Address +4:	Idle timeout value	0
Address +5:	Max. communication time	0
Address +6:	Command Number	14
Address +7:	Device number to receive the message	2
Address +8:	Function Code	64 Decimal or 40 Hexadecimal
Address +9:	Sub-function Code (hex)	32 Decimal or 20 Hexadecimal
Address +10:	Priority	0
Address +11:	Datagram Length (in bytes)	134
Address +12:	Datagram Content	0000 hex
Address +13:	Datagram Content	2200 hex
Address +14:	Datagram Content	8611 hex
Address +15:	Data to write to TAG (beginning TAG address)	AABB hex data, (BB -> first byte in TAG at address 1122H and AA -> second byte of TAG at address 1123H)
Address +...	Data to write to TAG (last TAG address)	CCDD hex data, (DD -> in second to last byte of TAG at address 11A1H and CC -> in the last byte of TAG at address 11A2H)

The Write Device Command gives back no reply.

Read Device Reply (continued)

Example 4.

This example illustrates how a Cancel Current Command can be performed to cancel any command with Wait previously sent to Transceiver channel 1 of BIGE device 2 link from rack 0, slot 3 of a GE PLC 90-70.

Address	Command Length	7
Address +1:	No Wait	0
Address +2:	Status Block memory type	8
Address +3:	Status Block offset	10
Address +4:	Idle timeout value	0
Address +5:	Max. communication time	0
Address +6:	Command Number	14
Address +7:	Device number to receive the message	2
Address +8:	Function Code	64 decimal 40 hex
Address +9:	Sub-function Code (hex)	30 hex
Address +10:	Priority	0
Address +11:	Datagram Length (in bytes)	2
Address +12:	Datagram Content	0100 hex

The Cancel Current Command gives back no reply.

Contents of the Status Block

The Status Block consists of 2 words of memory in which the Genius™ Bus Controller returns general information about the execution of the COMREQ command. After the successful execution of the COMREQ operation is performed, a value of 4 is returned in the lower word 1 of the Status Block.

Refer to the Genius™ Bus Controller User's Manual GFK-0398C for more details concerning the Status Block.

Possible Errors:

Errors returned by the Genius™ Bus Controller for the COMREQ status may be 1 of the following:

1. COMREQ Status: Low Word -> 8
 High Word-> 0

DEF.- Command terminated due to syntax error.
Caused by possible mis-formation in the COMREQ Command Block due to a data length out of range.

2. COMREQ Status: Low Word -> 16
 High Word-> 208

DEF.- Command terminated due to data error only partial data transfer.
Caused by possible data length value within the COMREQ Command Block set less than the actual incoming length.

3. COMREQ Status: Low Word -> 2048
 High Word-> 0

DEF.- Device did not accept the message or timed out.
Caused by possible time out error of a COMREQ #15 set to No Wait for reply and a Read Device instruction is performed with Wait.

Appendix

Removable Phoenix connectors used on the BIGE.

Number of positions	Type
2	MSTB 2.5/2-ST
3	MSTB 2.5/3-ST
4	MSTB 2.5/4-ST

BIGE Control Board Data Sheets

BALOGH

7699 Kensington Court
Brighton, MI 48116-8561
(248) 486-RFID

BIGE Control Board

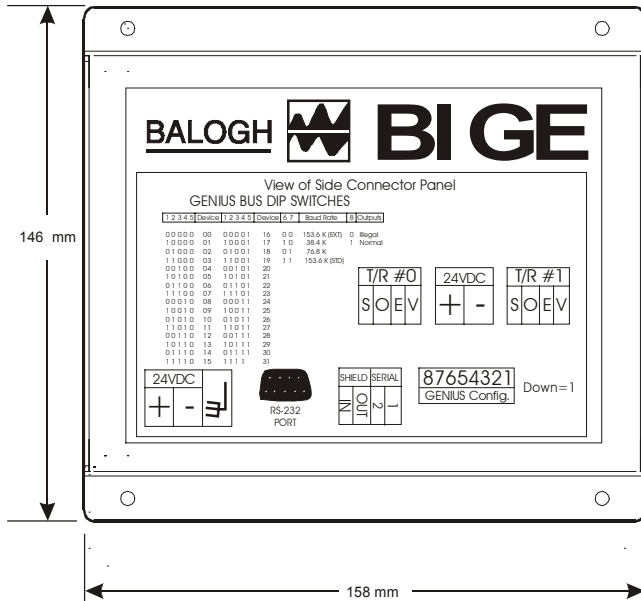

- Each BIGE Control Board can service a maximum of 2 Transceivers.
- Allows Reading and Writing of BALOGH OMA, and OMX TAGS.
- Reading of BALOGH "OF/OFR", TAGS executes user designed instructions for the control and management of data.
- Allows the interface of the BALOGH TAG RFID System to the General Electric Genius® Lan Via twisted pair serial connection.

BALOGH

7699 Kensington Court
Brighton, MI 48116-8561
(248) 486-RFID (7343)

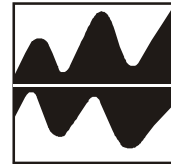

Characteristics at 25° C	Symbol	Unit	BIGE
V Supply (< 2% Ripple)	Vdc	V DC	24
Voltage Tolerance	Vdc	V DC	(+/-) 10%
Operational Current (without Transceiver)	Is	MA	500
Serial Communication			Genius LAN
Current Peak (without Transceiver)	Ip	A	2
Operational Environment			0% to 95% relative humidity (Non-Condensating)
MIN Ambient TEMP	Tmin	°C	0
MAX Ambient TEMP	TMAX	°C	+60
Protection Degree	IP		00
Weight	M	Kg	1.5
MAX Cable length between Control Board and Transceiver			50 Meters
Protected against Inverse Polarity			YES

Genius® is a registered trademark of the General Electric Company.

BIGE Control Board

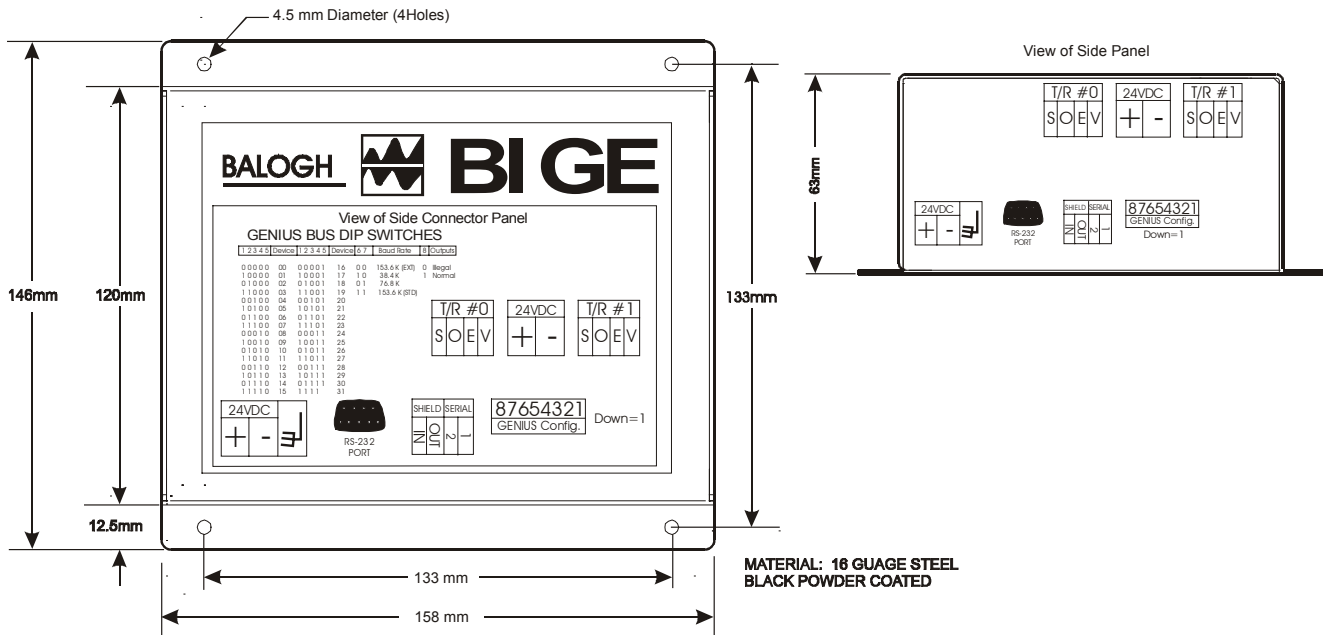

BIGE NEMA-12 ENCLOSURE (OPTIONAL EXTRA)

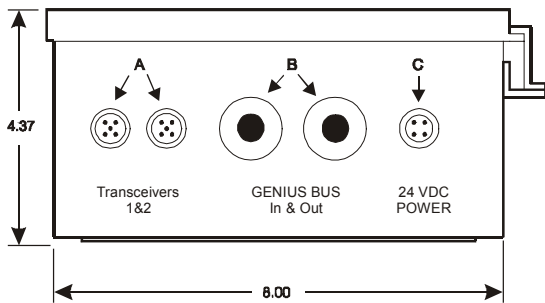

NOTE: Actual Dimensions are Approximate
All Dimensions are in Inches +/- 0.01 Inch

- A - BALOGH PM-FC 5-Pin
Pin 1 = +24VDC Pin 3 = Input
Pin 2 = Output Pin 4 = 0VDC
- B - BALOGH LAN Connector
- C - BALOGH PM-MC 4-Pin
Pin 1 = +24VDC
Pin 4 = 0VDC

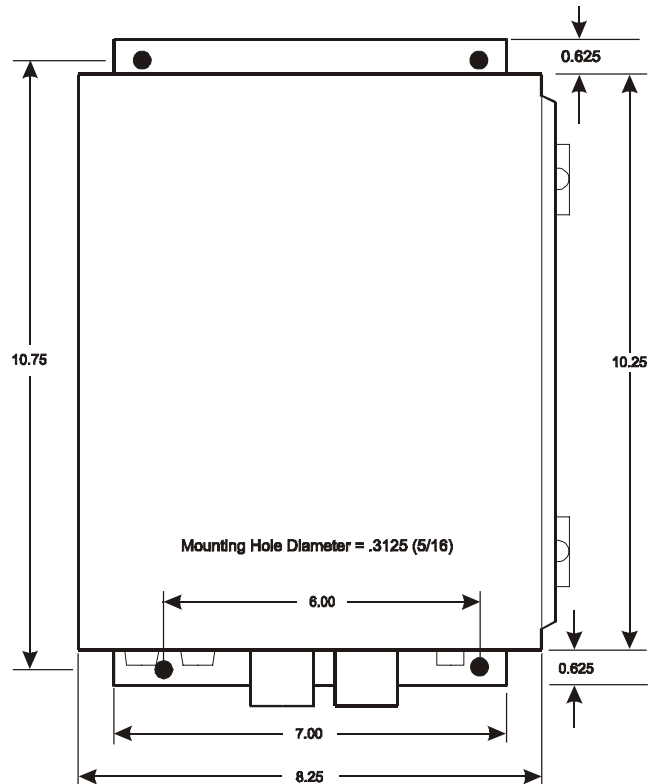

BIGE/X12/SAT Control Board

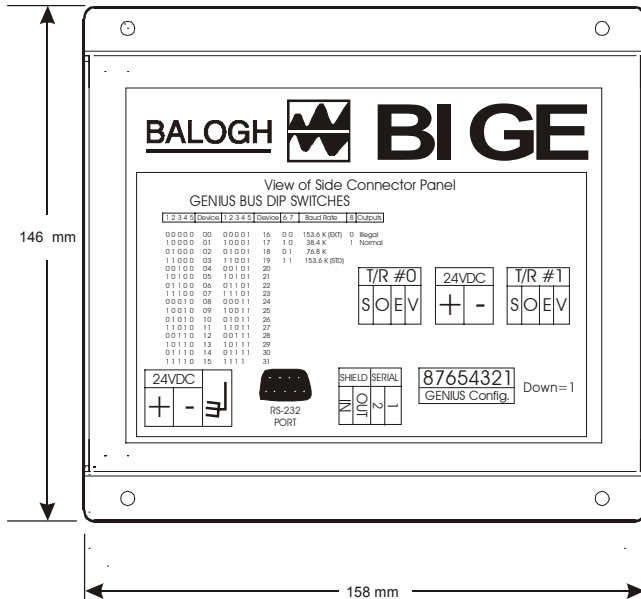

- Each BIGE Control Board can service a maximum of 2 Transceivers.
- Allows Reading and Writing of BALOGH OMA, and OMX TAGS.
- Reading of BALOGH "OF/OFR", TAGS executes user designed instructions for the control and management of data.
- Allows the interface of the BALOGH TAG RFID System to the General Electric Genius® Lan Via twisted pair serial connection.

BALOGH

7699 Kensington Court
Brighton, MI 48116-8561
(248) 486-RFID (7343)

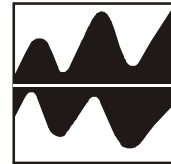

Characteristics at 25° C	Symbol	Unit	BIGE
V Supply (< 2% Ripple)	Vdc	V DC	24
Voltage Tolerance	Vdc	V DC	(+/-) 10%
Operational Current (without Transceiver)	Is	MA	500
Serial Communication			Genius LAN
Current Peak (without Transceiver)	Ip	A	2
Operational Environment			0% to 95% relative humidity (Non-Condensating)
MIN Ambient TEMP	Tmin	°C	0
MAX Ambient TEMP	TMAX	°C	+60
Protection Degree	IP		00
Weight	M	Kg	1.5
MAX Cable length between Control Board and Transceiver			50 Meters
Protected against Inverse Polarity			YES

Genius® is a registered trademark of the General Electric Company.

BIGE/X12/SAT Control Board

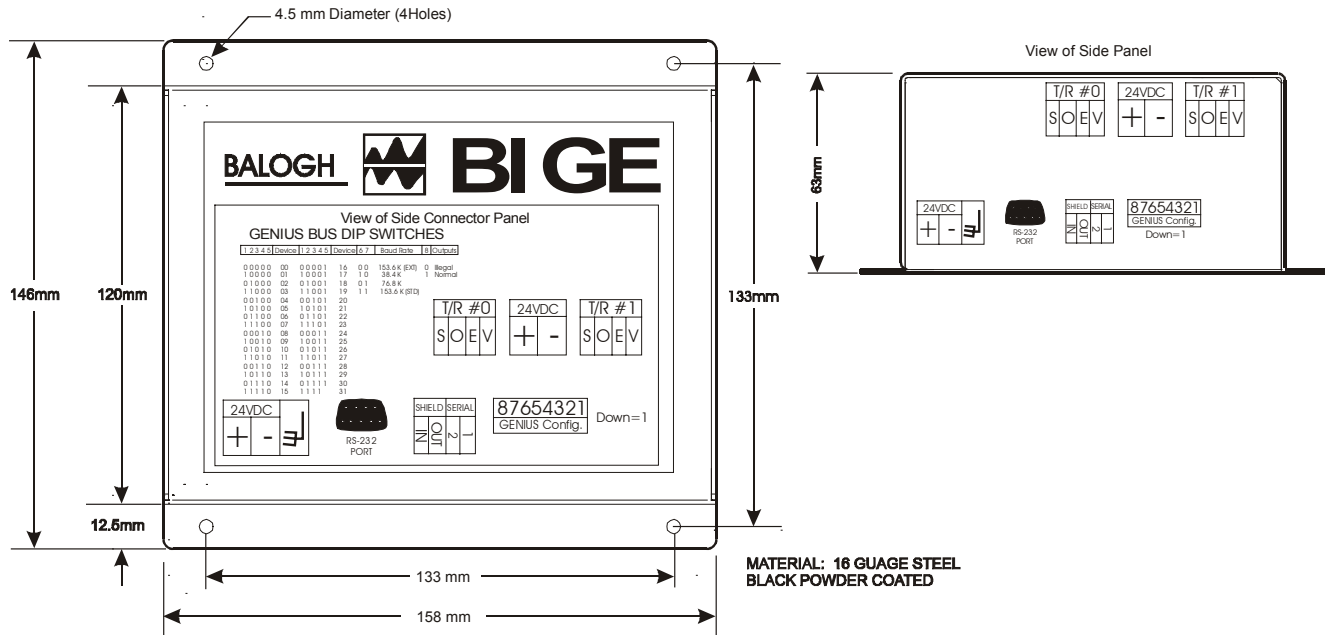

BIGE NEMA-12 ENCLOSURE

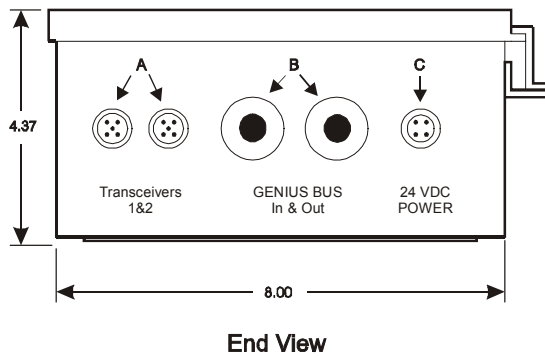

NOTE: Actual Dimensions are Approximate
All Dimensions are in Inches +/- 0.01 Inch

- A - BALOGH PM-FC 5-Pin
Pin 1 = +24VDC Pin 3 = Input
Pin 2 = Output Pin 4 = 0VDC
- B - BALOGH LAN Connector
- C - BALOGH PM-MC 4-Pin
Pin 1 = +24VDC
Pin 3 = 0VDC

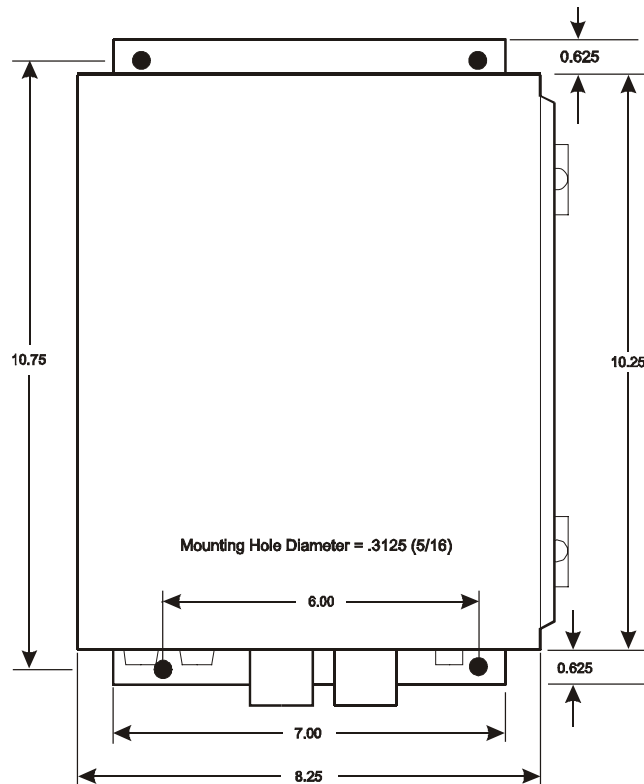

BALOGH RF Interface Via GENIUS[®] BUS Protocol

Max. Connection Limit Dictated by G.E. Specification

* Maximum Connection Limit Dictated by G.E. Specification

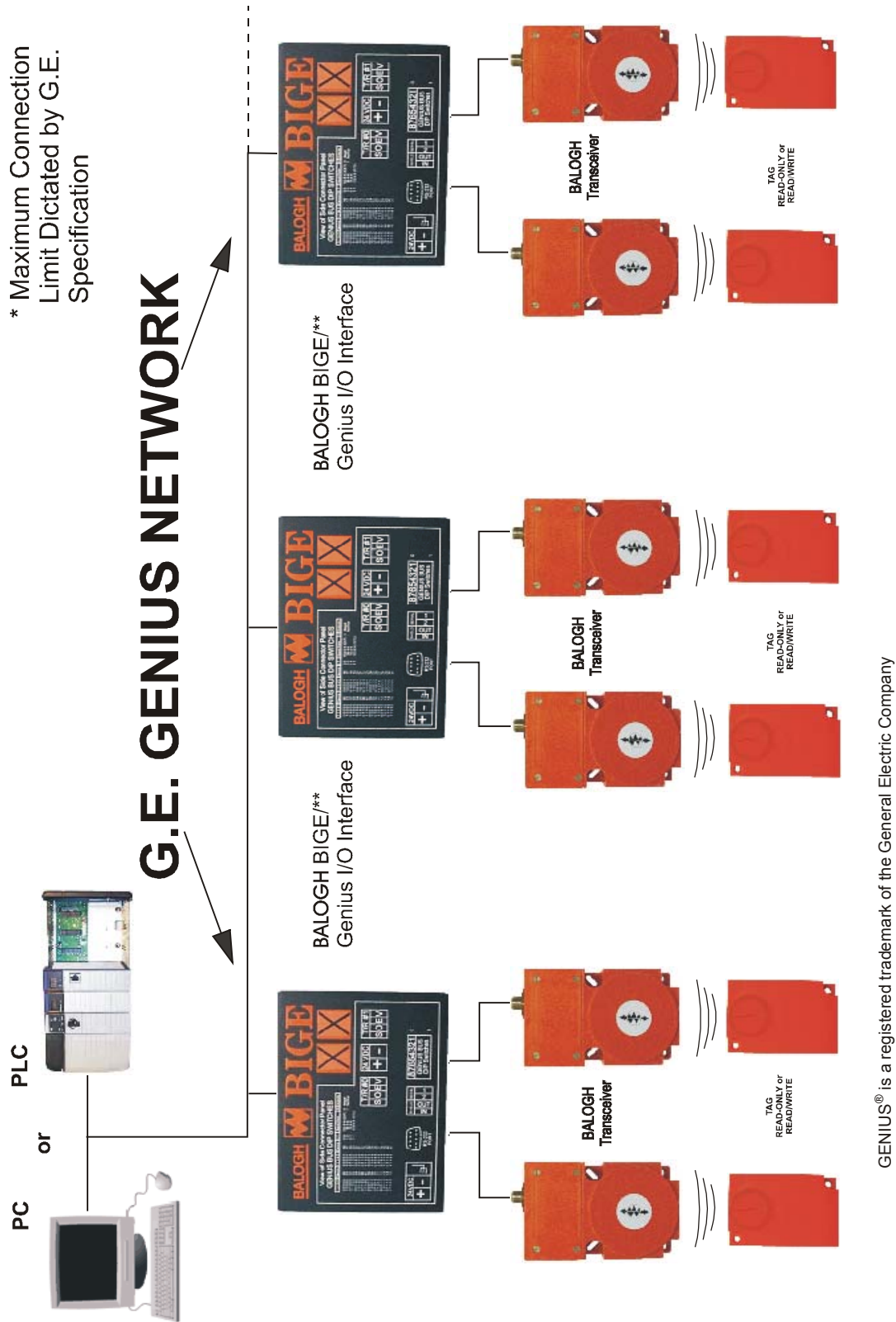

GENIUS[®] is a registered trademark of the General Electric Company